



170

174

11

12

Klemmring

Klemmring

Klemmring

11

7

# GreenTrellis System

The reproduction, distribution and utilization of this drawing as well as the communication of its contents to others without express authorization is prohibited. Offenders will be held liable for the payment of damages. All rights reserved in the event of the grant of a patent, utility model or design.

Weitergabe sowie Vervielfältigung dieser Zeichnung, Verwertung und Mitteilung ihres Inhalts ist verboten, soweit nicht ausdrücklich gestattet. Zuwiderhandlungen verpflichten zu Schadensersatz. Alle Rechte für den Fall der Patent-, Gebrauchsmuster- oder Geschmacksmusterverletzung vorbehalten.

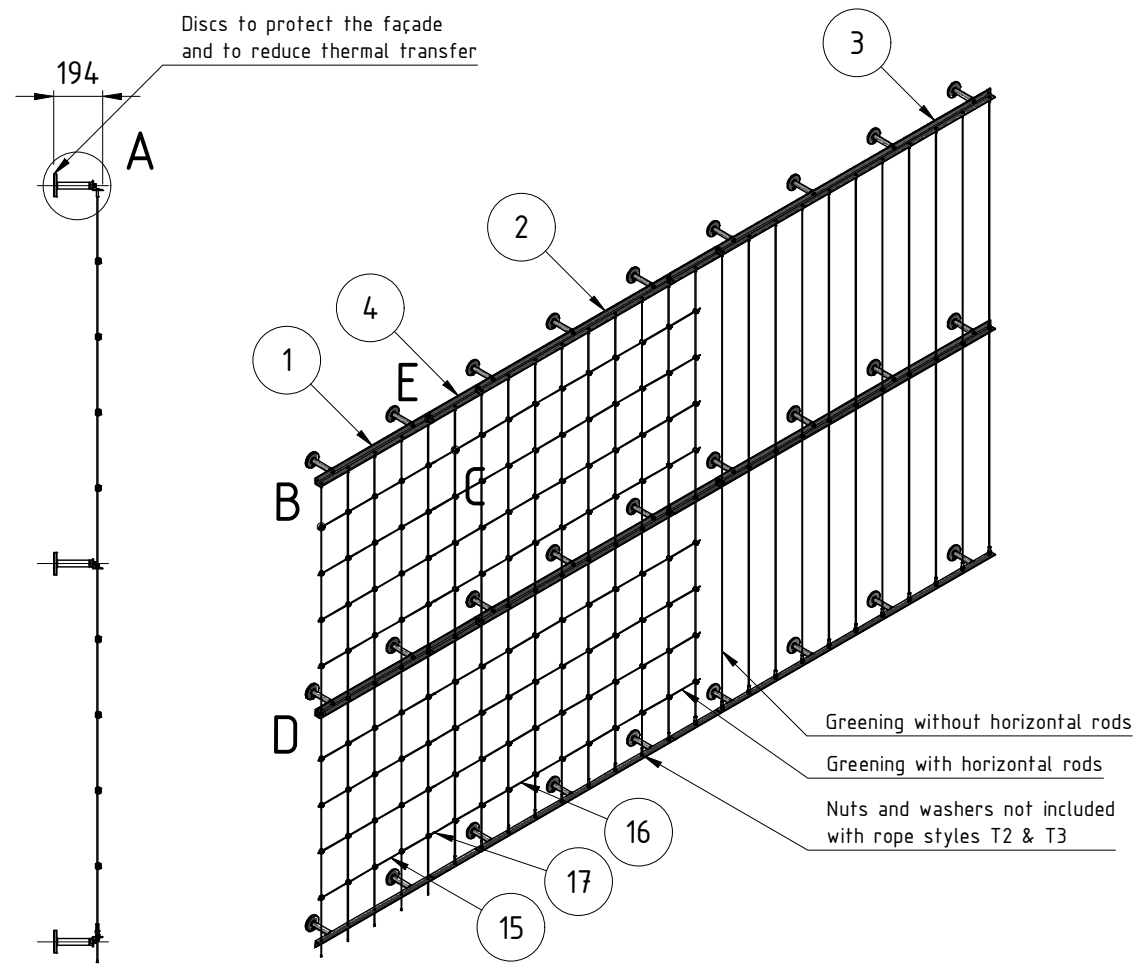
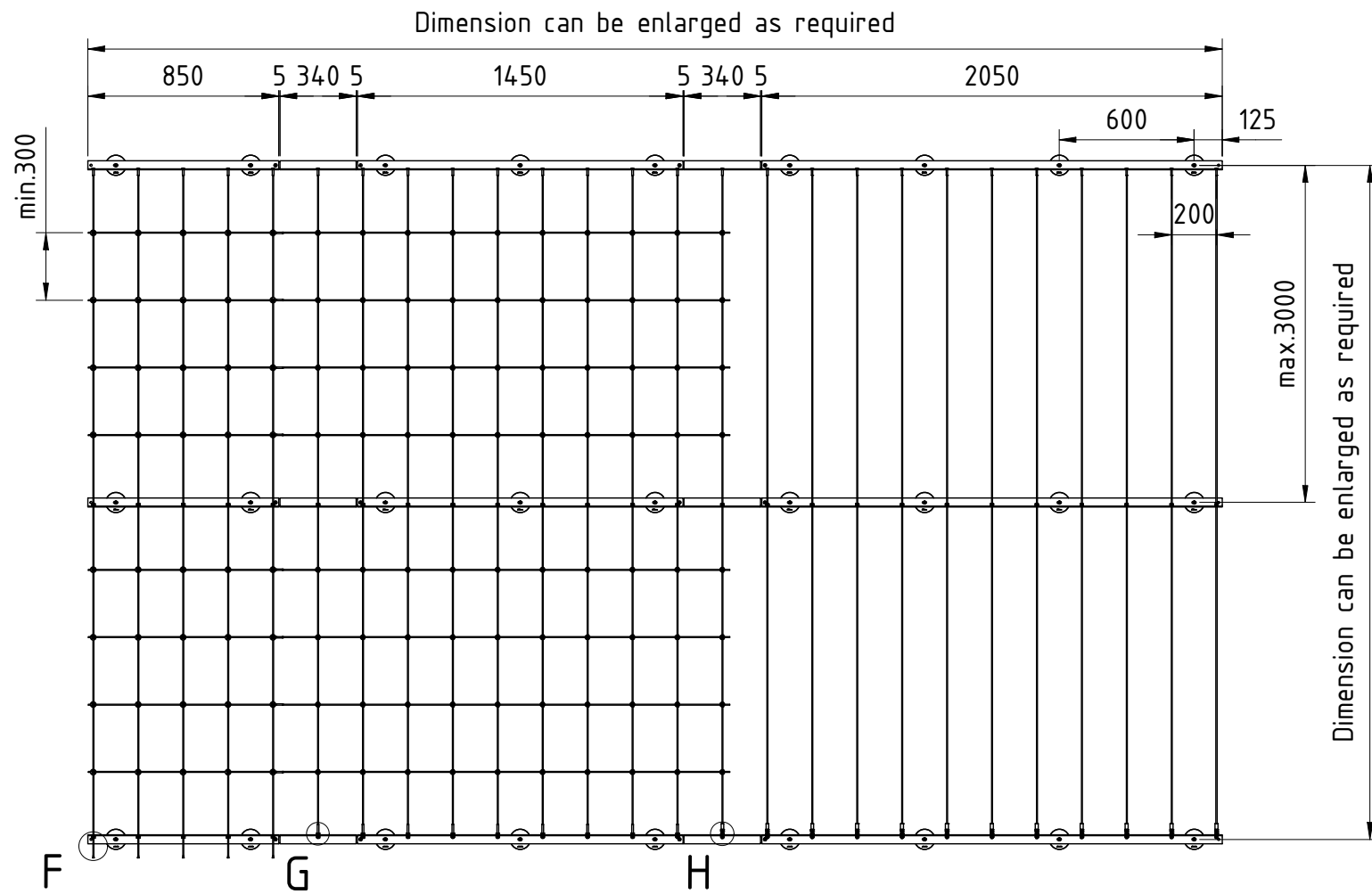

System for selection with rope styles T1 / T2 / T3 (20811-000x-xx), as pos. 7, 8, 9  
 Wall distances of 100mm, 150mm and 200mm recommended with spacers 30897-0xx0-10  
 Assembly material according to catalog G2 technical, p. 71  
 The whole system has been calculated and documented without turnbuckles  
 The maximal system dimensions have to be modified in case of large building heights or strong wind regions  
 The dimensions are not indicated according to scale

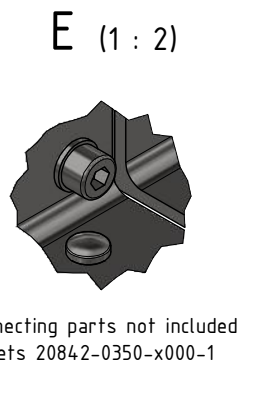
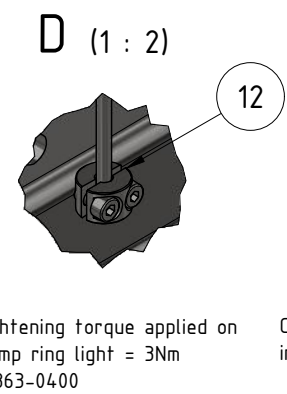
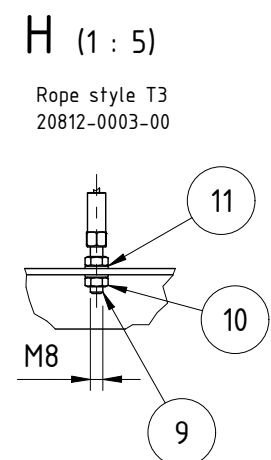
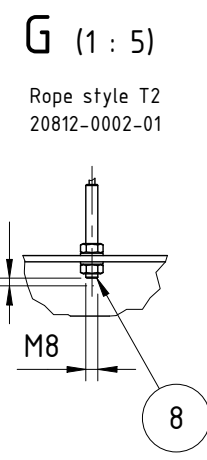
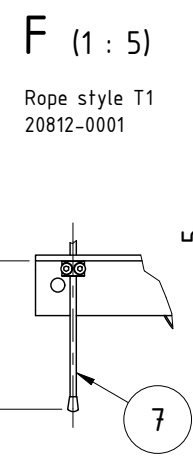
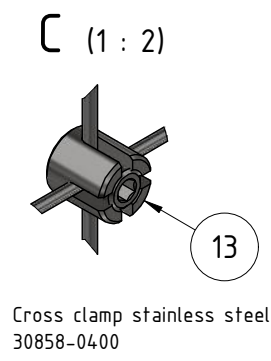
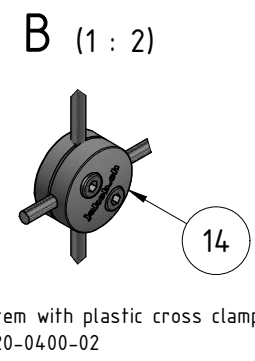
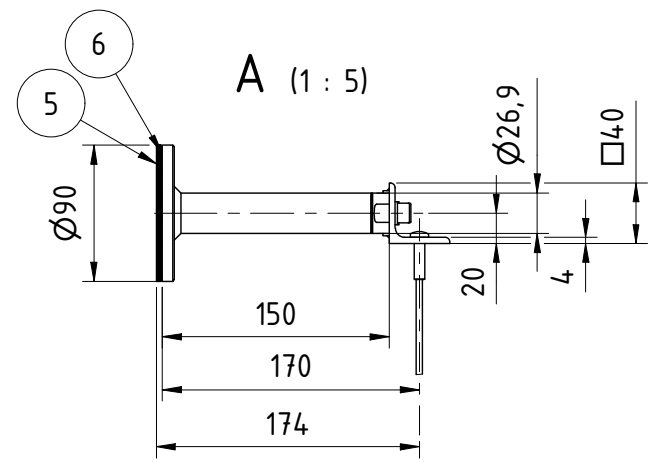

System with plastic cross clamp 30920-0400-02 or Cross clamp stainless steel 30858-0400

Tightening torque applied on clamp ring light = 3Nm 30863-0400  
 Connecting parts not included in sets 20842-0350-x000-1

17	8	30922-0400-30	Connecting sleeve for horizontal rod
16	8	30922-0400-00	Horizontal rod
15	8	30922-0400-00-0850	Horizontal rod 850
14	40	30920-0400-02	Cross clamp, plastic
13	80	30858-0400	Cross clamp
12	31	30863-0400	Clamp ring light
11	66	30896-0800	Washer DIN 125A A4
10	54	30892-0800	Hexagon nut DIN 934 M8 A4
9	12	20812-0003-00	Rope style T3, Assembly length b=?
8	9	20812-0002-01	Rope style T2, Assembly length b=?
7	5	20812-0001	Rope style T1, Assembly length b=?
6	3	30896-0802-80	Sliding disc for spacers
5	3	30896-0801-90	Protective disc for spacers
4	2	20842-0350-6000-1	GreenTrellis section connector 350, 6000
3	1	20842-2050-6150-11	GreenTrellis 2050, 6000, 150
2	1	20842-1450-6150-8	GreenTrellis 1450, 6000, 150
1	1	20842-0850-6150-5	GreenTrellis 850, 6000, 150

Pos.	Anz./Qty.	Art.-No. / Standard	Bezeichnung / Description	Gewicht / Weight										
				15.249 kg										
GreenTrellis System EN technical p. 27, 28														
Gezeichnet	lru	Datum	03.08.2020	<table border="1"> <tr> <td>Massstab / Scale</td> <td>1 : 30</td> </tr> <tr> <td>Geprüft</td> <td>lru</td> <td>Datum</td> <td>03.08.2020</td> </tr> <tr> <td>Freigegeben</td> <td>lru</td> <td>Datum</td> <td>03.08.2020</td> </tr> </table>	Massstab / Scale	1 : 30	Geprüft	lru	Datum	03.08.2020	Freigegeben	lru	Datum	03.08.2020
Massstab / Scale	1 : 30													
Geprüft	lru	Datum	03.08.2020											
Freigegeben	lru	Datum	03.08.2020											
Blatt 1 von 1														

**Jakob**<sup>®</sup>  
 Rope Systems  
 Jakob AG  
 3555 Trubschachen  
 Switzerland

173351  
 Index  
 A